

TIVOLI

mod-8823

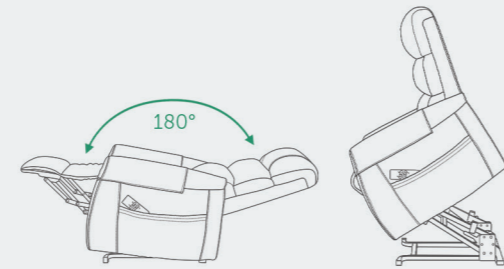

PROGETTO
RELAX

DIMENSIONS

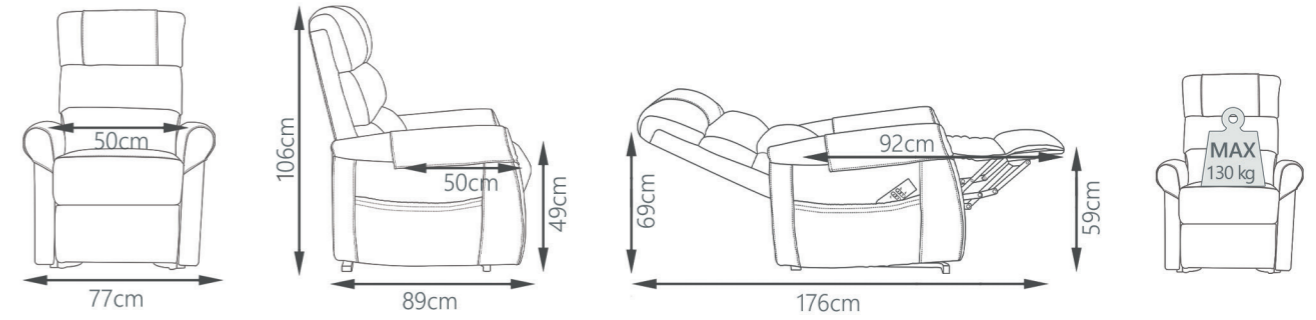

SPECIFICATIONS

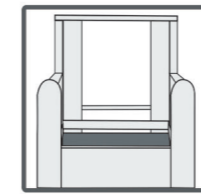

EN / FR

Solid wood and plywood
Bois massif et contre-plaqué

IT / DE

Legno massiccio e compensato
Massivholz und Sperrholz

NL / ES

Massief hout en multiplex
Madera maciza y madera contrachapada

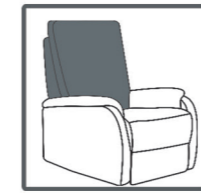

Webbing
Sangles élastiques

Cinch
Gurtband

Singelband
Cincha

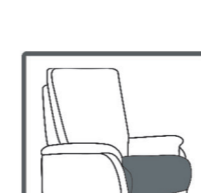

Sinuous springs
Ressorts nosag

Molle Nosag
Zig-zag Federn

Nosag veren
Muelles zig-zag

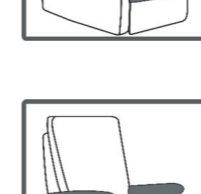

Pocket springs
Ressorts ensachés

Molle insacchettate
Taschenfedern

Pocket veren
Muelles ensacados

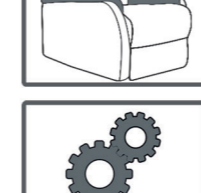

Polyurethane foam
Mousse de polyuréthane

Schiuma poliuretanic
Polyurethan Schaum

Polyurethaan schuim
Espuma de poliuretano



Recliner armchair with dual motors power lift
Fauteuil releveur avec bi-moteurs

Poltrona reclinabile lift bi-motore
Relaxsessel 2-motorisch mit Aufstehhilfe

Relaxfauteuil 2-motorig met sta-op hulp
Sillón relax de 2 motores con función elevadora

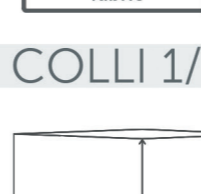

Fabric Cobra 100% polyester
Tissu Cobra, 100% polyester

Tessuto Cobra. 100% polyester
Cobra-Stoff, 100% Polyester

Stof Cobra, 100% polyester
Tela Cobra, 100% poliéster

COLLI 1/1



N.W.: 51,5 KG
G.W.: 57 KG
CBM.: 0,40 m³
78cm x 77cm x 66cm (LxWxH)

TIVOLI

lift chair



COLORS

FUNCTIONS



cobra 

PC009 dark grey 

PC015 bronze 

