

- D** Montageanleitung **GB** Assembly instruction
FR Notice de montage **IT** Istruzioni di montaggio
NL Handleiding voor de montage **PL** Instrukcja montażu
CZ Montážní návod **SK** Návod na montáž
HU Szerelési útmutató **RO** Instrucțiuni de montaj
TR Montaj talimatı **RU** Инструкция по монтажу



30min

Dokument-Nr.: 0001
Ausgabe: 20160506

D	Eventuelle Druckstellen in der Polsterung, welche beim Transport entstehen können, verschwinden bei Gebrauch nach einiger Zeit von allein.
FR	De bosses dans la sellerie, qui peuvent survenir pendant le transport, disparaître après un certain temps d'utilisation.
NL	Elke deuken in de bekleding, die zich kunnen voordoen tijdens het transport, verdwijnt na enige tijd van gebruik.
CZ	Jakékoliv důlky v čalounění, které mohou vzniknout během přepravy, zmizí po určité době používání.
HU	Bármely horpadás a kárpit, során esetlegesen felmerülő szállítás eltűnnek egy idő után a használat.
TR	Döşemelik herhangi ezik, taşıma sırasında ortaya çıkabilecek, kullanımı bir süre sonra kaybolur.

GB	Any dents in the upholstery, which may arise during transport, disappear after some time of usage.
IT	Le ammaccature nella tappezzeria, che possono verificarsi durante il trasporto, scompaiono dopo un certo tempo di utilizzo.
PL	Wszelkie wgniecenia w tapicerce, która może powstać w trakcie transportu, znikają po pewnym czasie użytkowania.
SK	Akékoľvek jamky v čalúnení, ktoré môžu vzniknúť počas prepravy, zmizne po určitej dobe používania.
RO	Orice urme de lovituri în tapițerie, care pot apărea în timpul transportului, dispărea după un timp de utilizare.
RU	Любые вмятины в обивке, которые могут возникнуть во время перевозки, исчезают через некоторое время использования.

0
10
20
30
40
50
60
70
80
90
100
110
120
130
140
150
160
170
180
190
200

Service•Assistenza•Dienstverlening•Serwis Servis•Szerviz•Сервисная служба	
Name•Nom•Nomo•Naam• Nazwa•Jméno•Názov•Név• Denumire•Isim•Название	
Nr. No. •N°•Homeno•C•Sz	
Typr•Type•Tip•Típus•Tipo• ТИП	
	
	

D	Zur Befestigung der Schrauben bitte nur den beiliegenden Inbusschlüssel verwenden. Durch die Benutzung einer Bohrmaschine oder eines Akkuschaubers kann es dazu kommen, daß die Schrauben zu fest angezogen werden und die Gewindebuchsen überdrehen.
GB	To fix the screws, please use only the enclosed Allen key. By using a power drill or a cordless screwdriver, it may happen that the screws are tightened too much and cause to overwind the screw thread.
FR	Pour fixer les vis, s'il vous plaît utiliser uniquement la clé Allen fournie. En utilisant une perceuse ou une visseuse sans fil, il peut arriver que les vis sont trop serrées et causer d'enrouler le filet.
IT	Per fissare le viti, si prega di utilizzare solo la chiave Allen inclusa nella confezione. Utilizzando un trapano elettrico o un cacciavite a batteria, può accadere che le viti siano serrate troppo e far antiavvolgimento la filettatura della vite.
NL	Om de schroeven vast te stellen, gebruik dan alleen de bijgeleverde inbussleutel. Door het gebruik van een boormachine of een accuschroevendraaier, kan het gebeuren dat de schroeven te hard aangedraaid en veroorzaken op de schroefdraad doordraaien.
PL	Aby naprawić śruby, prosimy używać tylko załączonego klucza imbusowego. Za pomocą wiertarki lub wkrętkarki akumulatorowej, może zdarzyć się, że śruby są dokręcone zbyt dużo i spowodować overwind śruby.
CZ	Chcete-li šrouby, prosím používejte pouze přiložený imbusový klíč. Pomocí vrtačky nebo akumulátorový šroubovák, může se stát, že jsou šrouby utaženy příliš a způsobit, aby overwind závit šroubu.
SK	Ak chcete skrutky, prosím použijajte iba priložený imbusový kľúč. Pomocou vrtačky alebo akumulátorový skrutkovač, môže sa stať, že sú skrutky utiahnuté príliš a spôsobiť, aby overwind závit skrutky.
HU	Ahhoz, hogy rögzítse a csavarokkal, kérjük, csak a mellékelt imbuszkulccsal. Segítségével egy fűrógép, vagy egy akkus csavarhúzó, előfordulhat, hogy a csavarok meghúzásakor túl sok, ami a túlhúzó a csavar menet.
RO	Pentru a remedia șuruburile, vă rugăm să folosiți numai închisă cheia Allen. Prin folosirea unui burghiu de putere sau o șurubelniță cu acumulator, se poate întâmpla ca șuruburile sunt strânse prea mult și determina să overwind filet.
TR	Vidaları sabitlemek için, sadece kapalı Allen anahtarını kullanın. Bir matkap veya bir akülü tornavida kullanılarak, vidaları çok sıkıldığından emin olur ve vida sarmak neden olabilir.
RU	Чтобы исправить винты, пожалуйста, используйте только прилагаемый шестигранный ключ. Используя дрель или шуруповерт, может случиться, что все винты затянуты слишком много, и привести перекручивать резьбу.

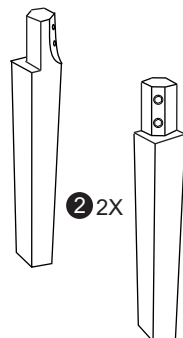
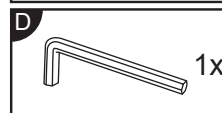
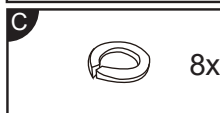
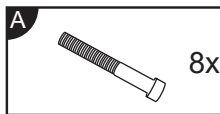

1.1 1X

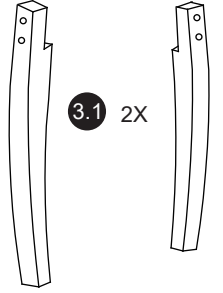
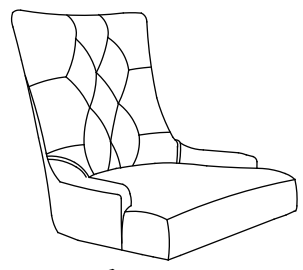

1

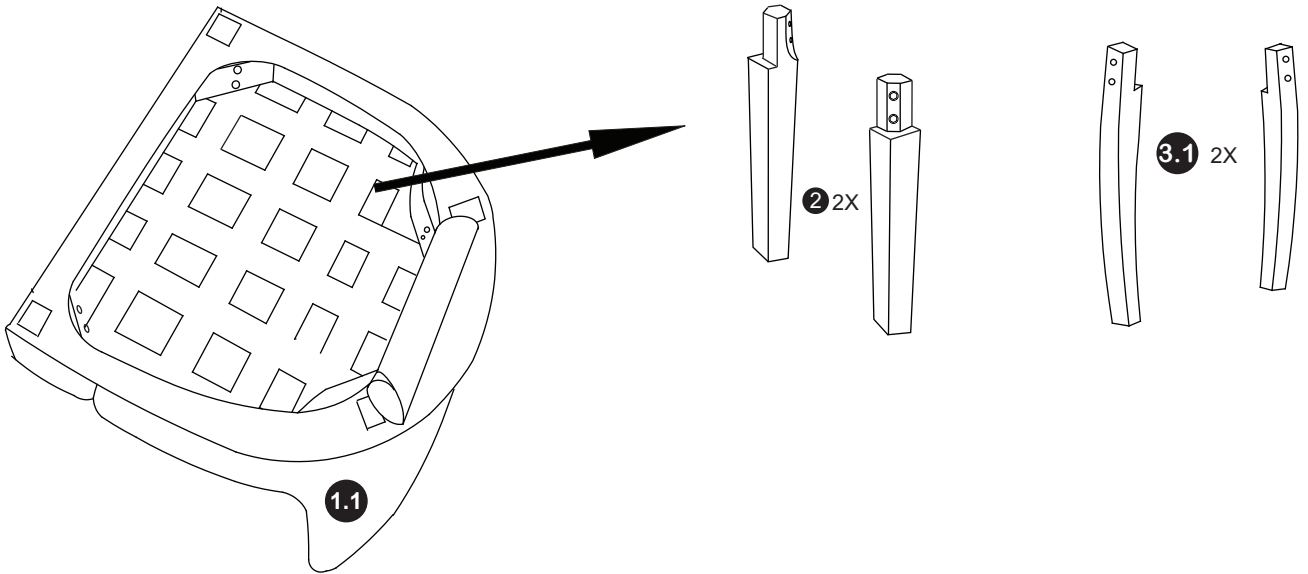



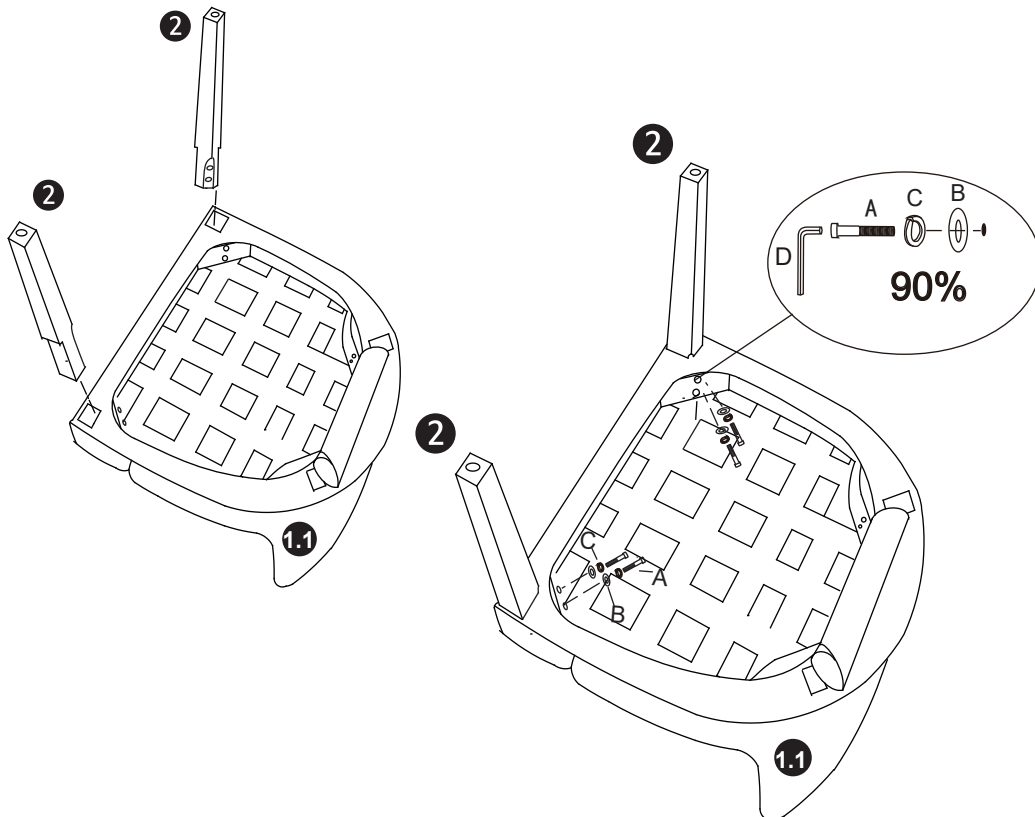
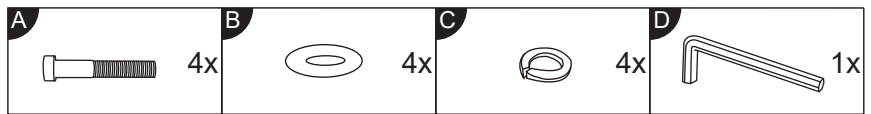

2

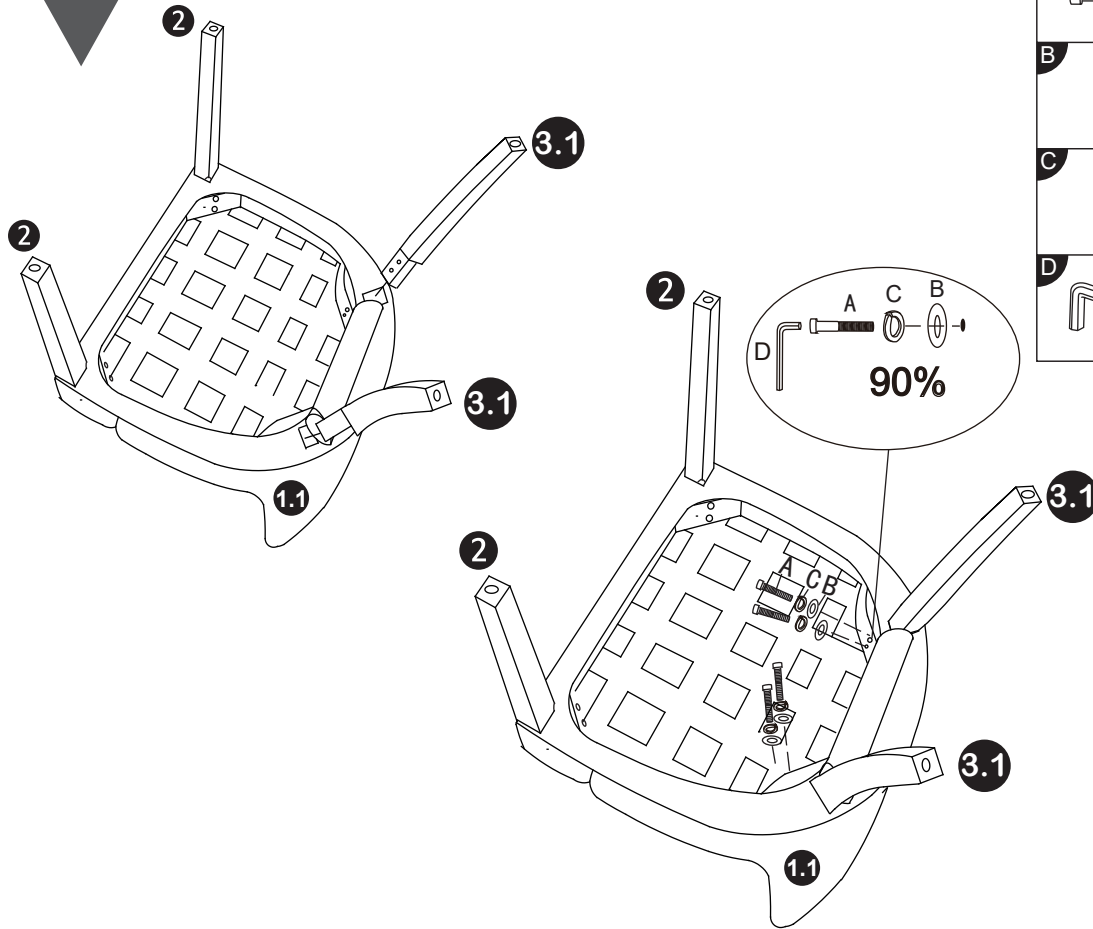

3



A		4x
B		4x
C		4x
D		1x

4

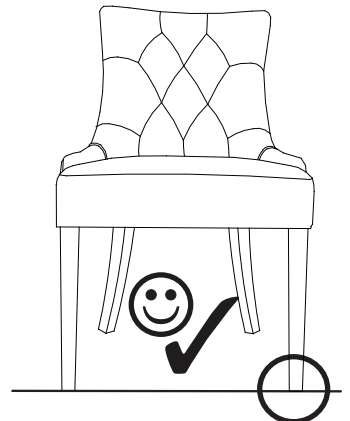
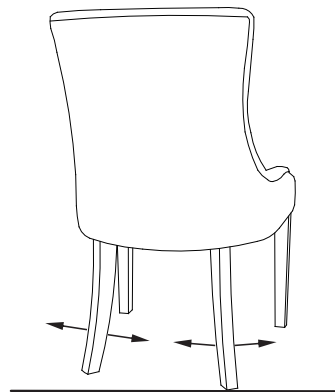
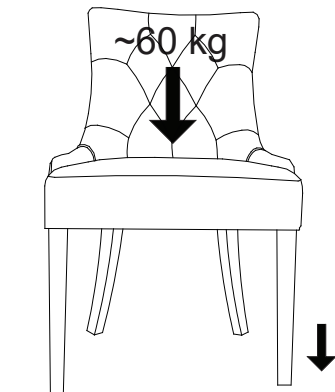
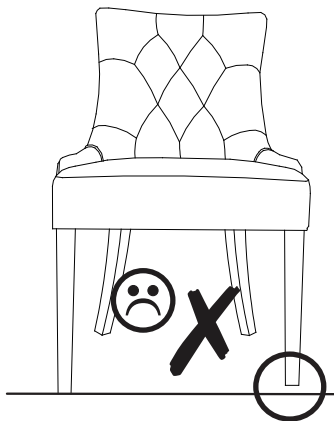
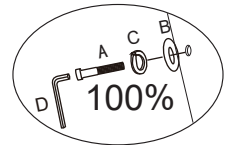
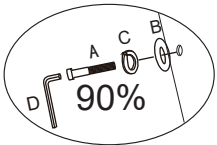

5

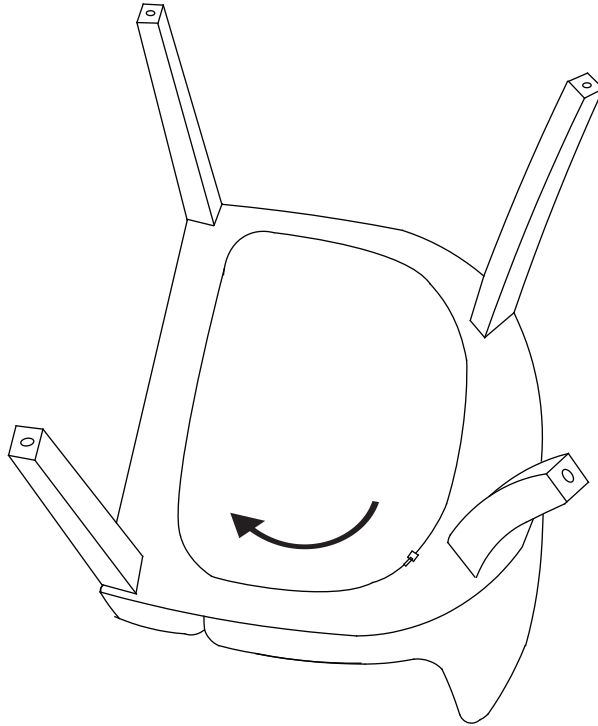

6

