

STAR DR3-DR4

enfilade - dressoir - cabinet

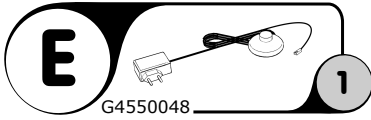

DR3

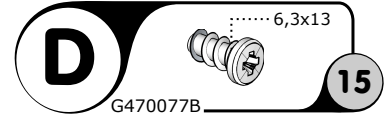
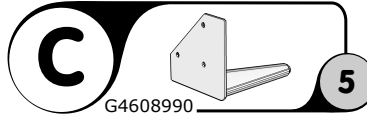
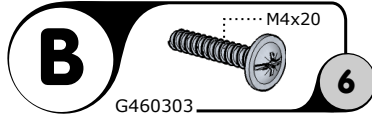
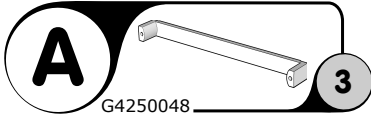
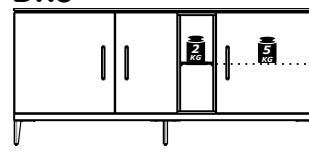

1842MM

DR4

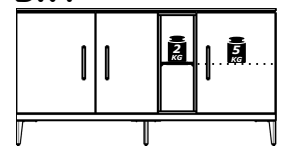

1582MM

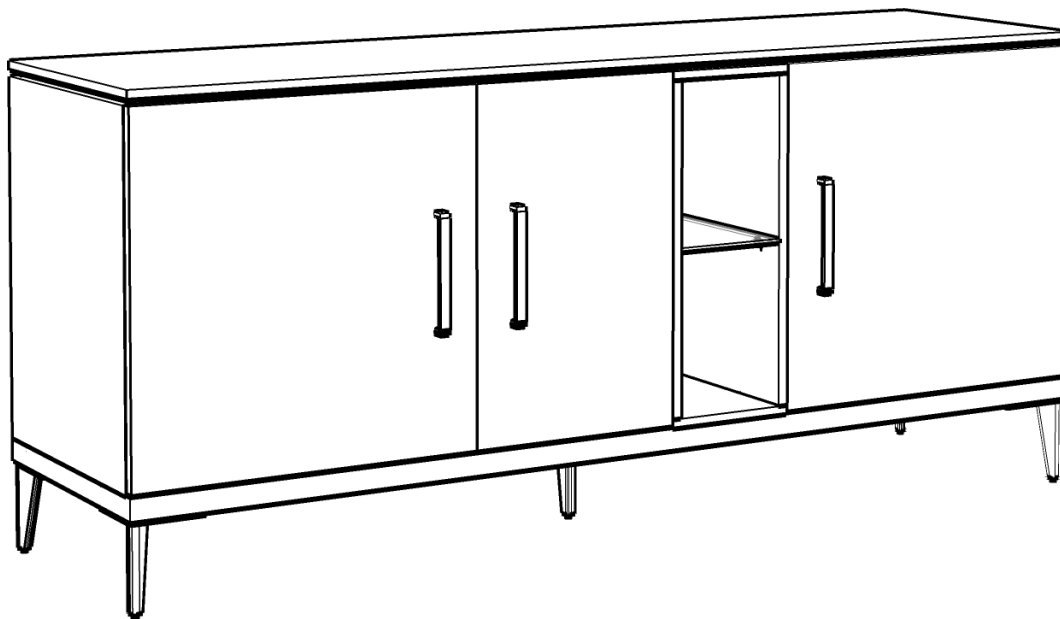

NL**ONDERHOUDSTIPS**

Oppervlakte kunststofdecor houtstructuur. Onderhoud: met lichte vochtige doek reinigen en hierna direct droog wrijven. De meubels zijn niet voor vochtige ruimten (bad, keuken etc.) bestemd. Vocht op het bovenblad direct opnemen. Montagetekening opbergen.

Het meubel moet door een vakkundig persoon, zoals in de handleiding staat beschreven worden gemonteerd. Door verkeerde montage kunnen gevaren ontstaan.

D**HINWEISE FÜR DIE PFLEGE**

Oberflächen Kunststoff-Dekor Holznachbildung. Pflegehinweis: Mit leicht feuchtem Tuch reinigen, sofort trocken nachwischen. Möbel nicht für Feuchträume geeignet (Bad, Küche etc.). Nässe auf Oberfläche unverzüglich abwischen. Aufbauanleitung aufbewahren.

Das Möbel muss durch eine fachkundige Person entsprechend der Aufbauanleitung montiert werden. Bei fehlerhafter Montage kann es zu Gefahren kommen.

EN**ADVISE ON MAINTENANCE**

All surfaces in laminated wood colour finishes. Maintenance: clean with slightly moistened cloth, wipe dry immediately. Not suited for damp locations (kitchen, bathroom etc.). Wipe off wetness at once. Retain manual instruction.

The unit must be put together by a specialist according to the assembly instructions. Hazards may arise in case of incorrect assembly.

F**CONSEILS D' ENTRETIEN**

Panneaux de particules revêtus d'un film polymère. Entretien: utiliser un chiffon légèrement humide et repasser de suite avec un autre sec. Meuble inadapté aux pièces humides (bain, cuisine etc.). Toute trace de liquide est à essuyer immédiatement. Notice de montage à conserver.

Le meuble doit être monté par une personne spécialisée en la matière, conformément à l'instruction de montage. En cas d'erreur de montage, des dangers peuvent se manifester.

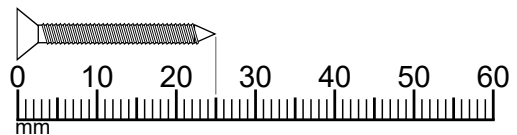
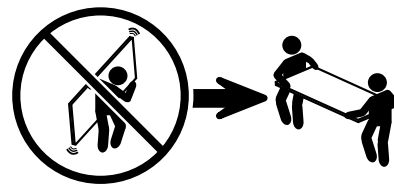
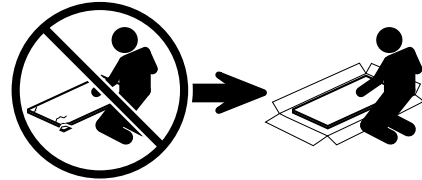
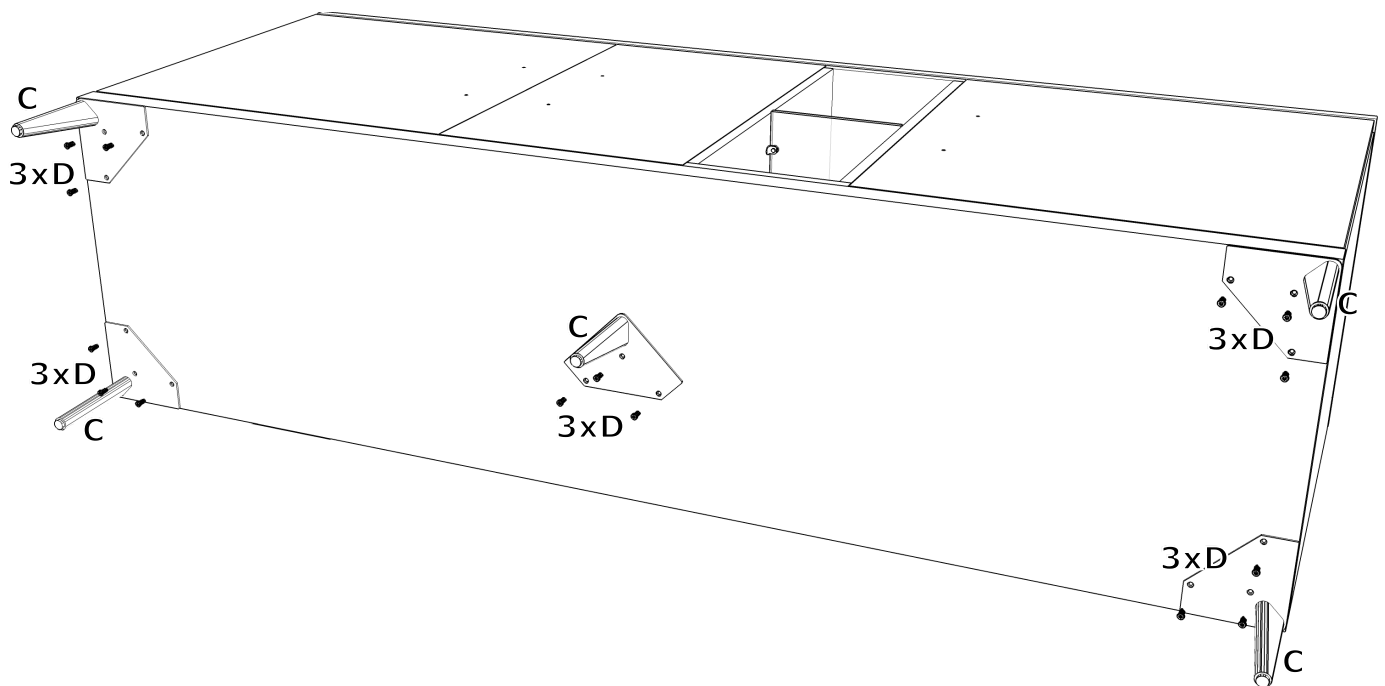
**1****C**

G4608990

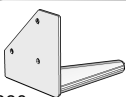
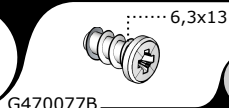
**5****D**

G470077B

15

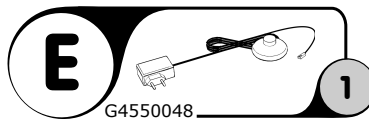
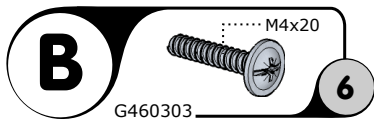
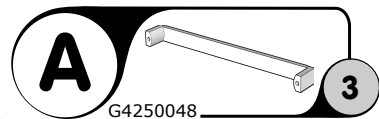
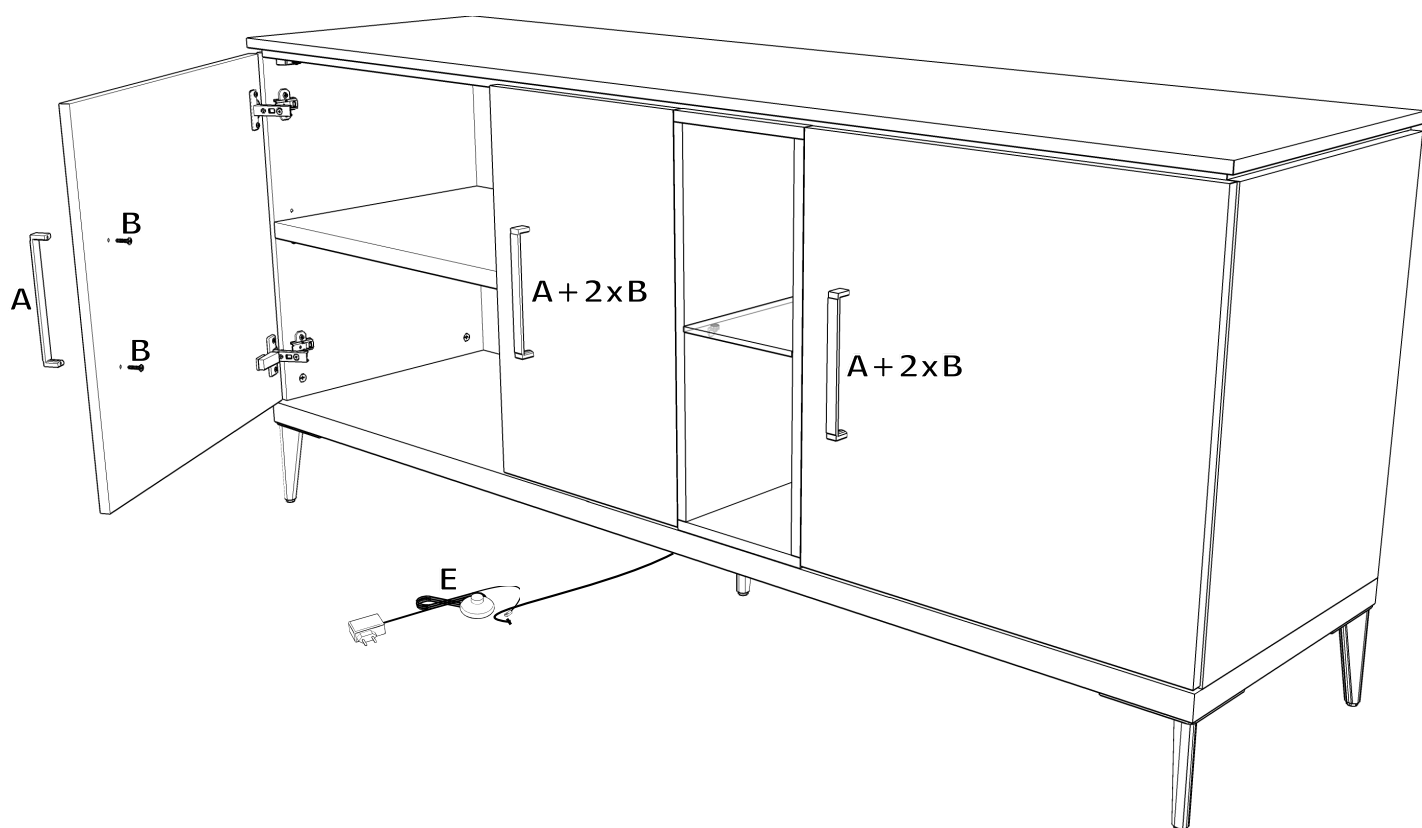

GEGEVENS AANKOPER

INFORMATIONS ACHETEUR - BUYER INFORMATION - KAUFER INFORMATIONEN

WINKEL

MAGASIN - SHOP - GESCHÄFT

PLAATS

LIEU - TOWN - ORT

ORDERBEVESTIGINGSNUMMER

N° DE CONFIRMATION DE LA COMMANDE - ORDER CONFIRMATION N°

KLEUR

COULEUR - COLOR - FARBE

AANKOOPDATUM

DATE DE L'ACHAT - DATE OF PURCHASE - KAUFDATUM

UW REFERENTIE

REFERENCE - REFERENCE - REFERENZ

FACTUURNUMMER

NUMÉRO DE FACTURE - INVOICE NUMBER - RECHNUNGSNUMMER

8

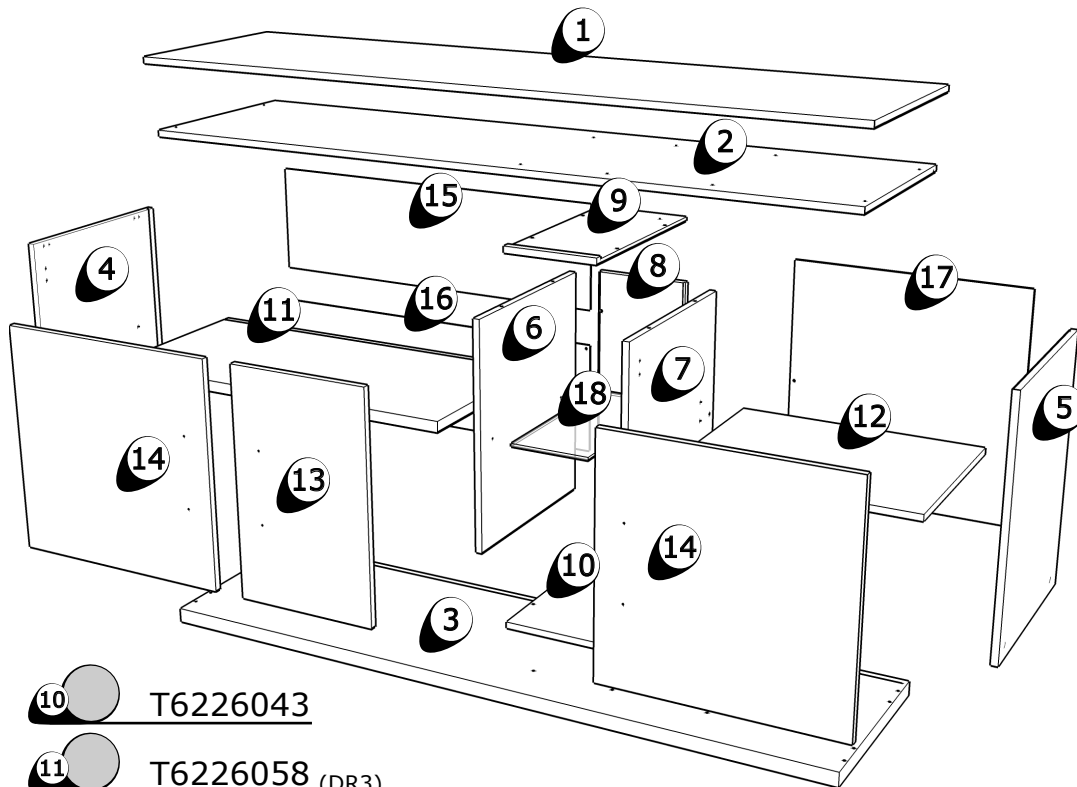
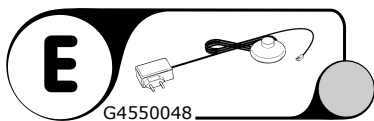
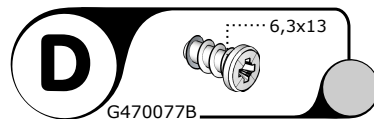
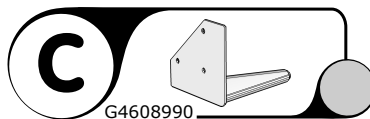
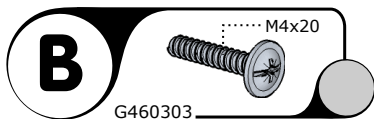
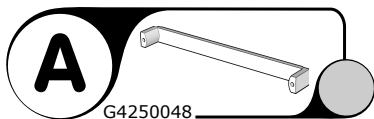

1 T6226028 (DR3)

1 T6226029 (DR4)

2 T6226033 (DR3)

2 T6226034 (DR4)

3 T6226038 (DR3)

3 T6226039 (DR4)

4 T6226045

5 T6226048

6 T6226051

7 T6226054

8 T6226100

9 T6226041

10 T6226043

11 T6226058 (DR3)

11 T6226059 (DR4)

12 T6226062 (DR3)

12 T6226063 (DR4)

13 T6226091

14 T6226090 (DR3)

14 T6226092 (DR4)

15 G100205 L 987 B291 (DR3)

15 G100205 L 857 B291 (DR4)

16 G100205 L 987 B303 (DR3)

16 G100205 L 857 B303 (DR4)

17 G100205 L 614 B607 (DR3)

17 G100205 L 614 B477 (DR4)

18 G4105057

TOELICHTING EXPLICATIONS - EXPLANATION - ERKLÄRUNG